

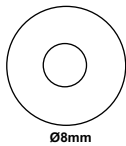

3x12 mm

A
10x



Ø8mm

B
32x



8 x 25mm

C
32x

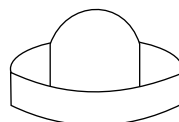

D
2x



E
2x

F 2x

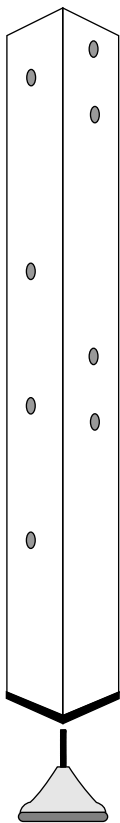

G 2x

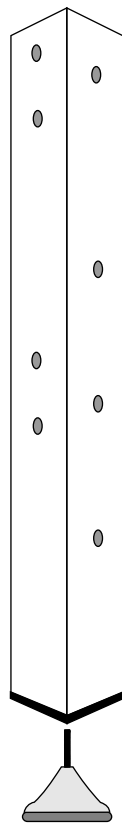

H 2x

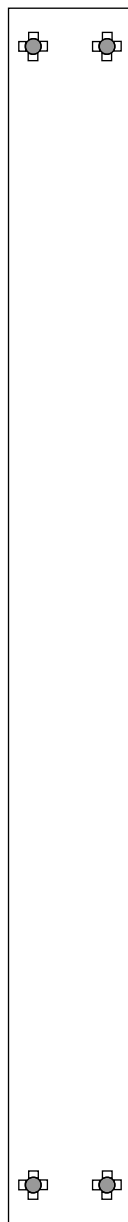

I 2x

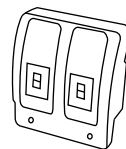
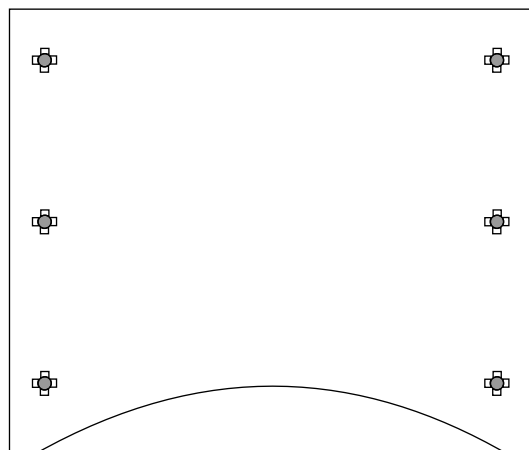

L 1x

J 2x

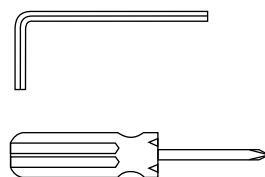
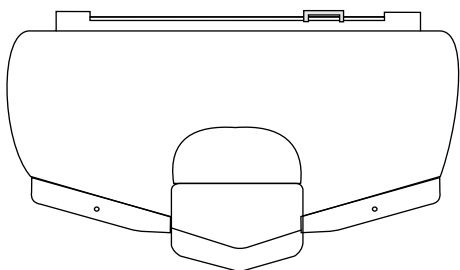

K 1x

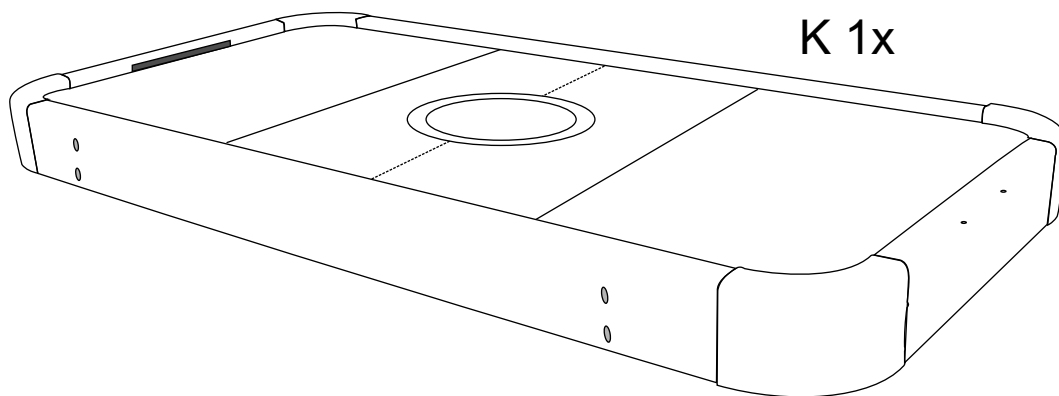

1

2

