



3 x 12mm

A
16x



4 x 16mm

B
6x

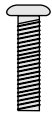

4 x 18mm

C1
26x



w4mm

C2
26x



4x16mm

D
32x

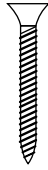

4 x 25mm

E
4x

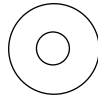

Ø6mm

F
16x



5 x 50mm

G
12x

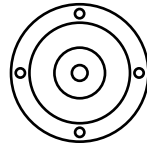

H
4x

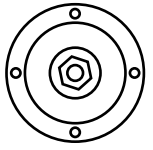

I
4x

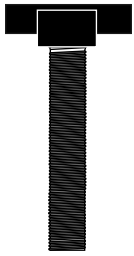

J
4x



6 x 50mm

K
12x



W 6mm

L
4x



W 8mm

M
4x

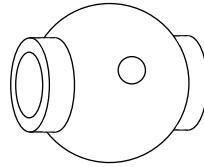

N
4x



O
16x



P
32x

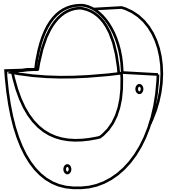

Q
2x

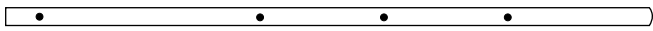

R 4x

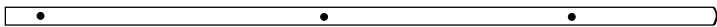

S 2x



T 2x



U 11x

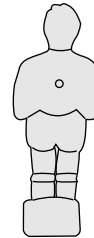

V 11x

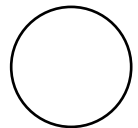

X 3x



R1 8x



R2 8x



W 12x



Y 2x

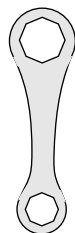
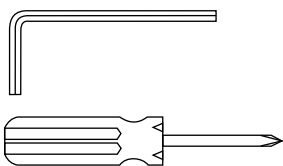

2x

1

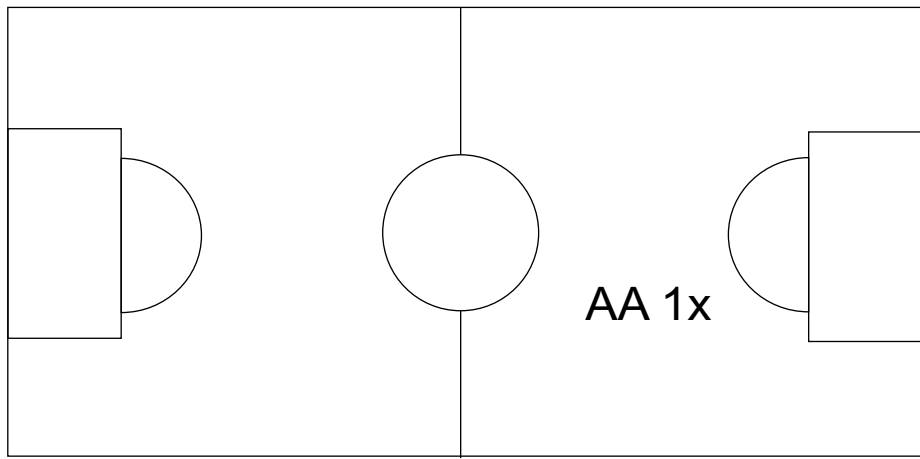

AA 1x

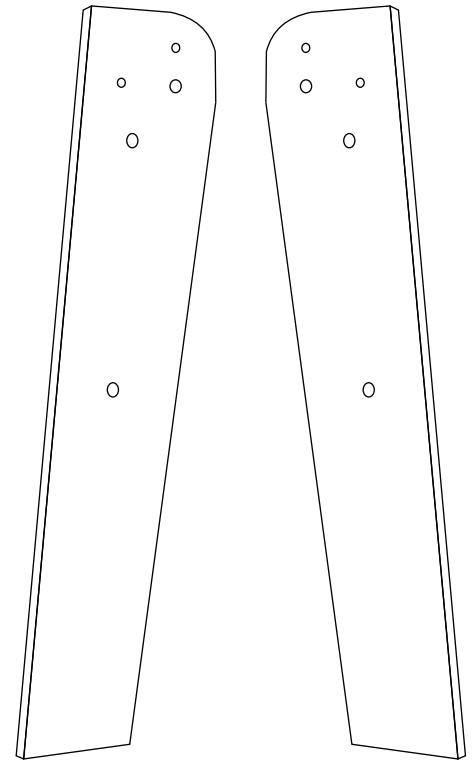

IA 1x

IB 1x

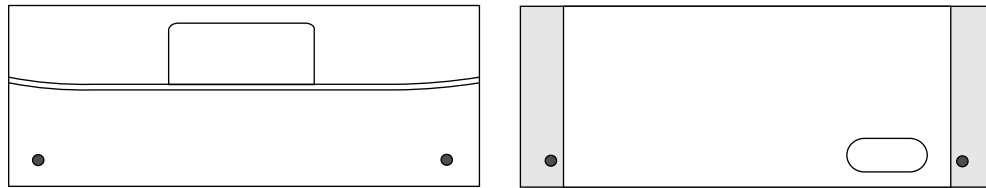

BB 2x

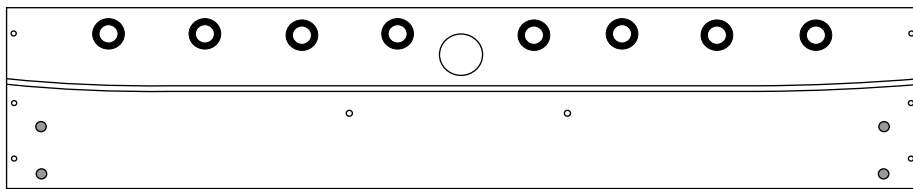

EE 2x

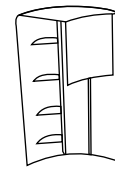

FF 2x

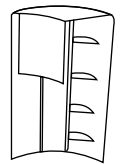

GG 2x

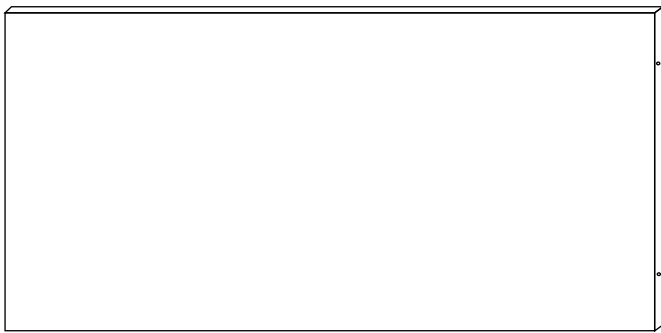

HH 2x

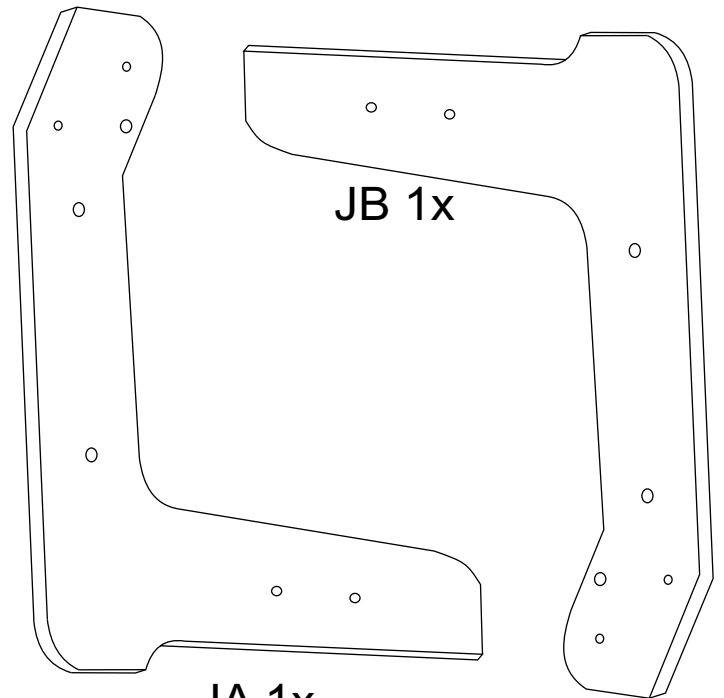

JB 1x

JA 1x

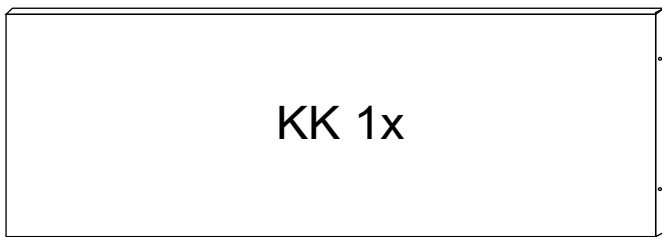

KK 1x

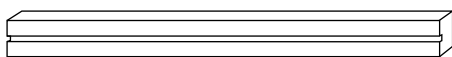

CC 2x

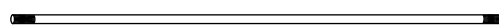

DD 2x

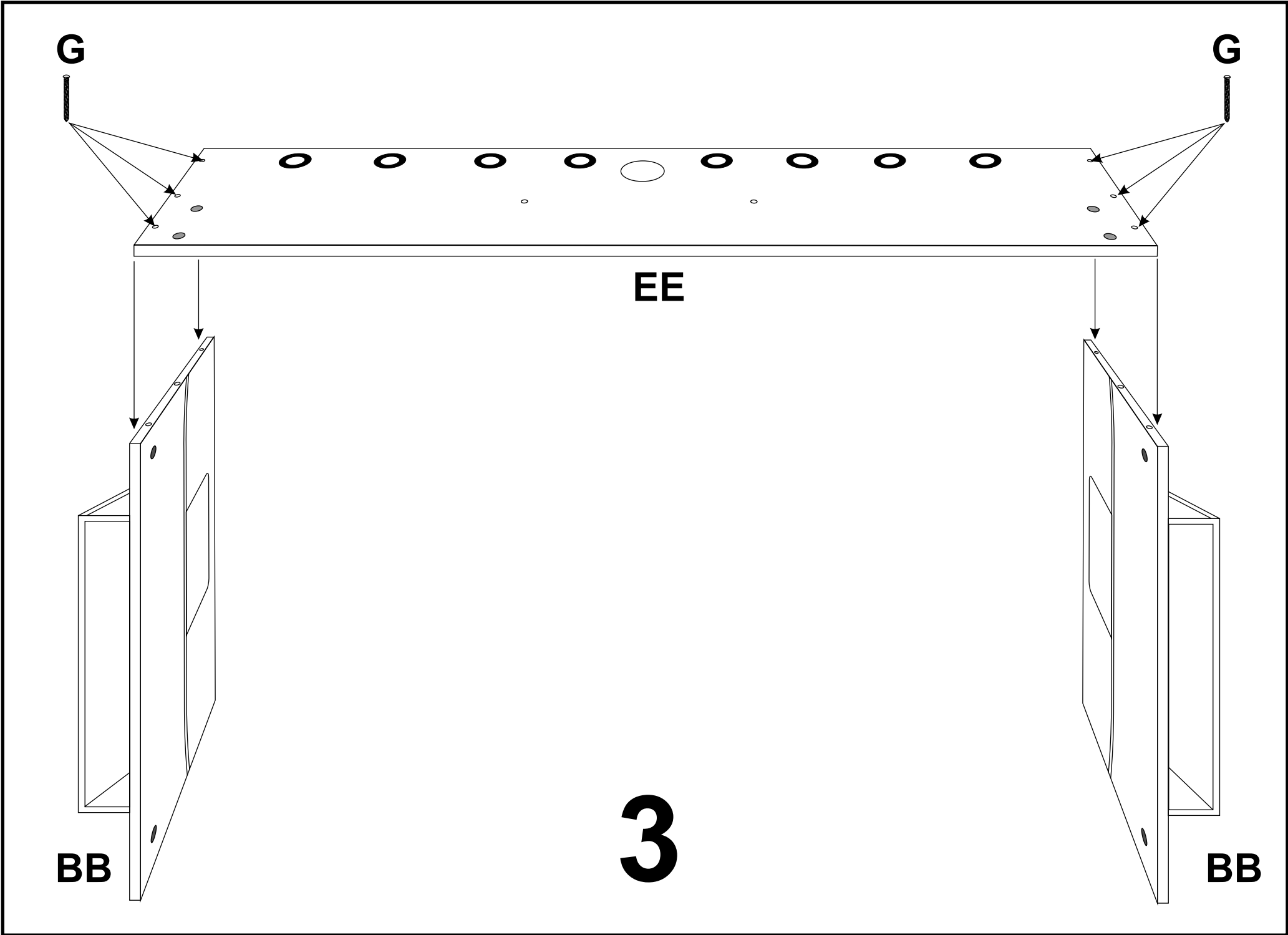

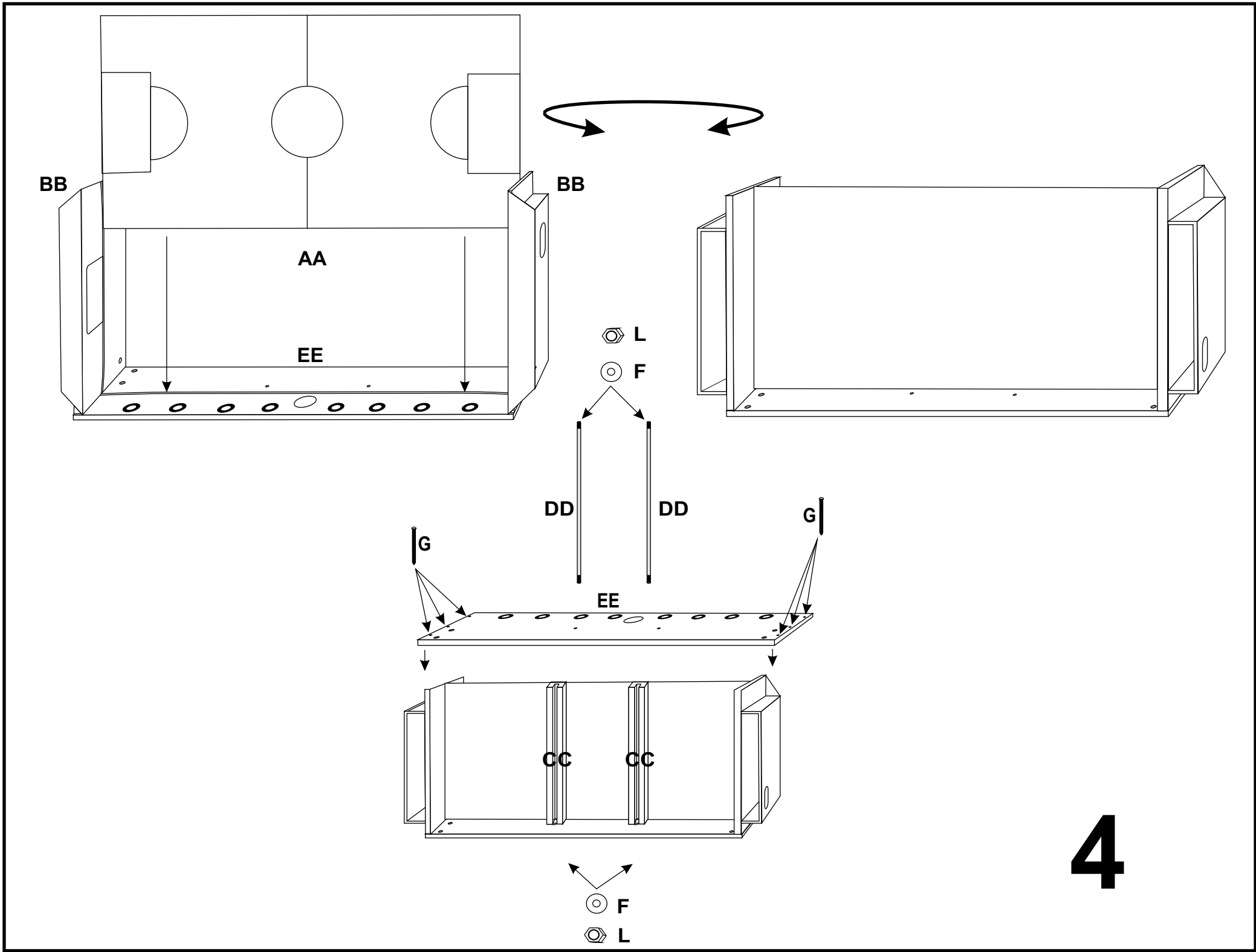

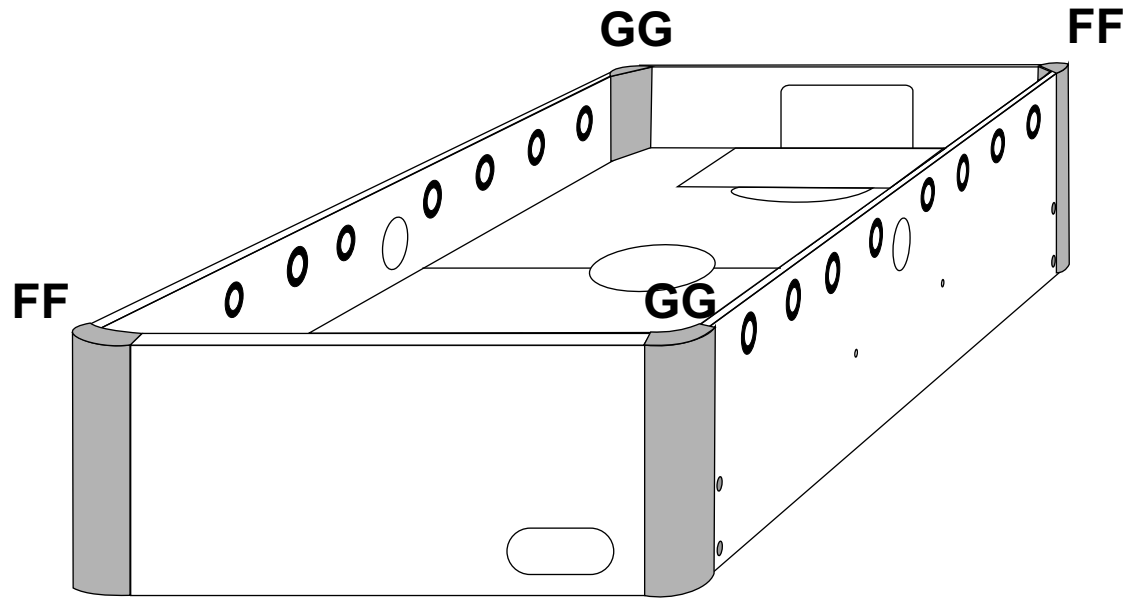
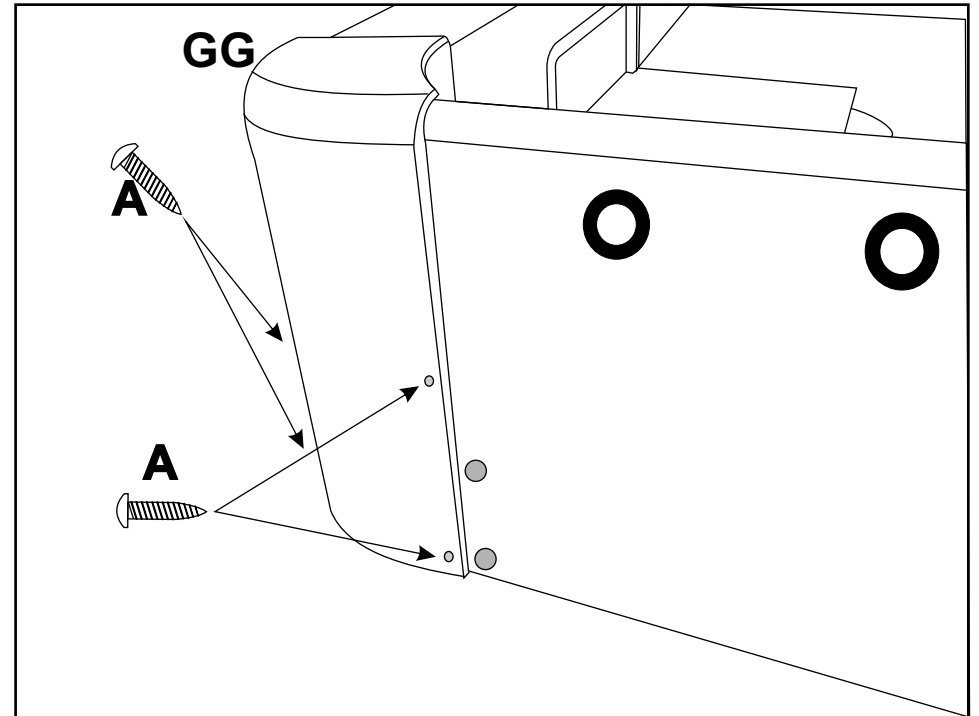
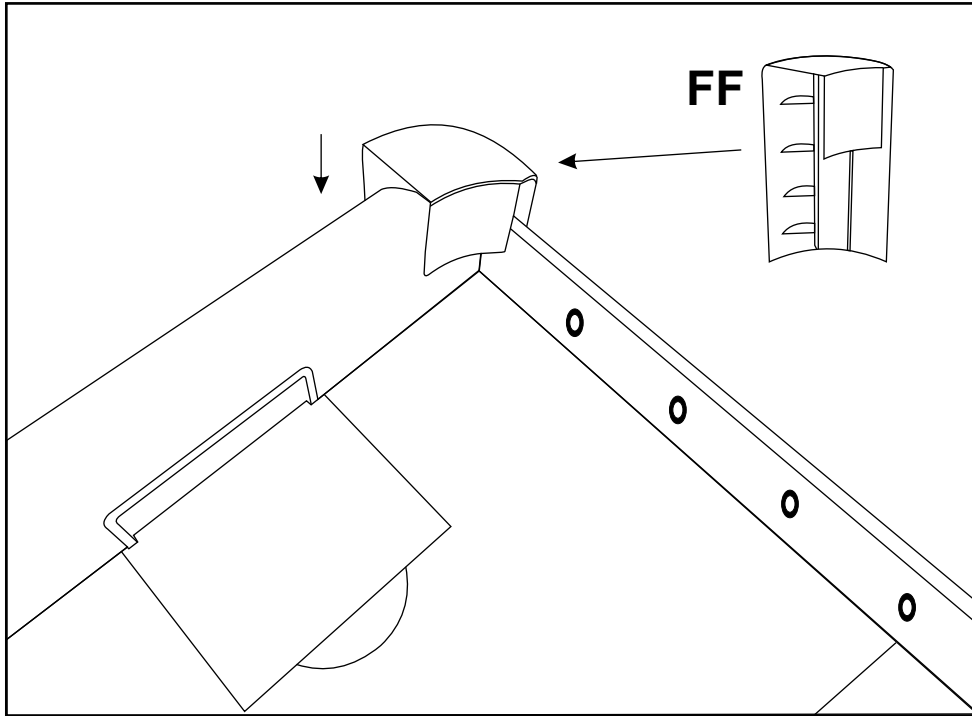

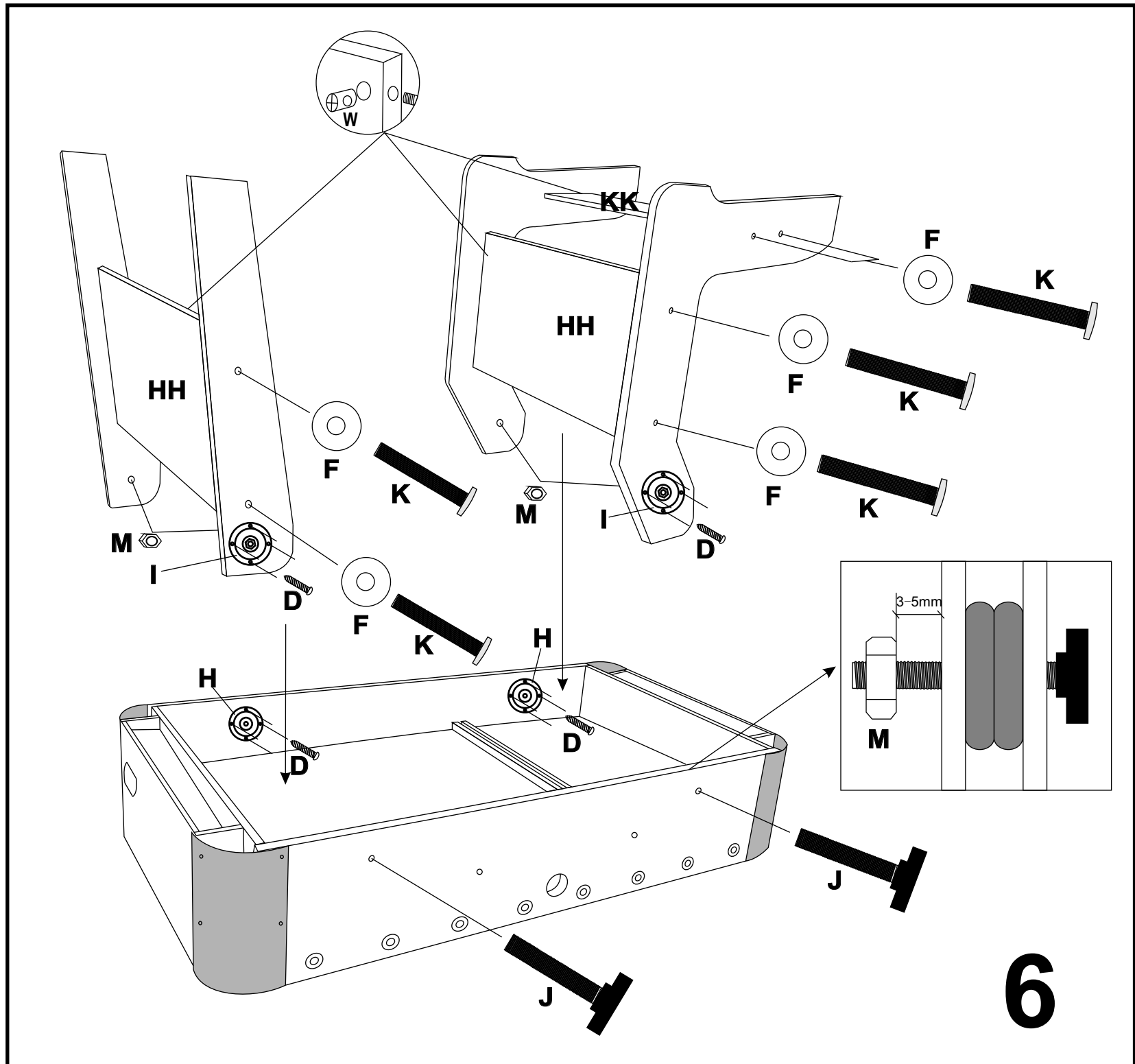

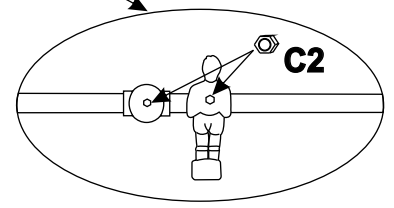
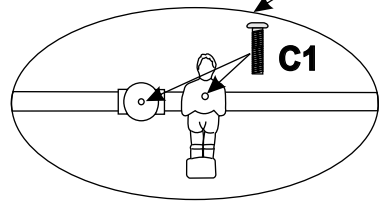
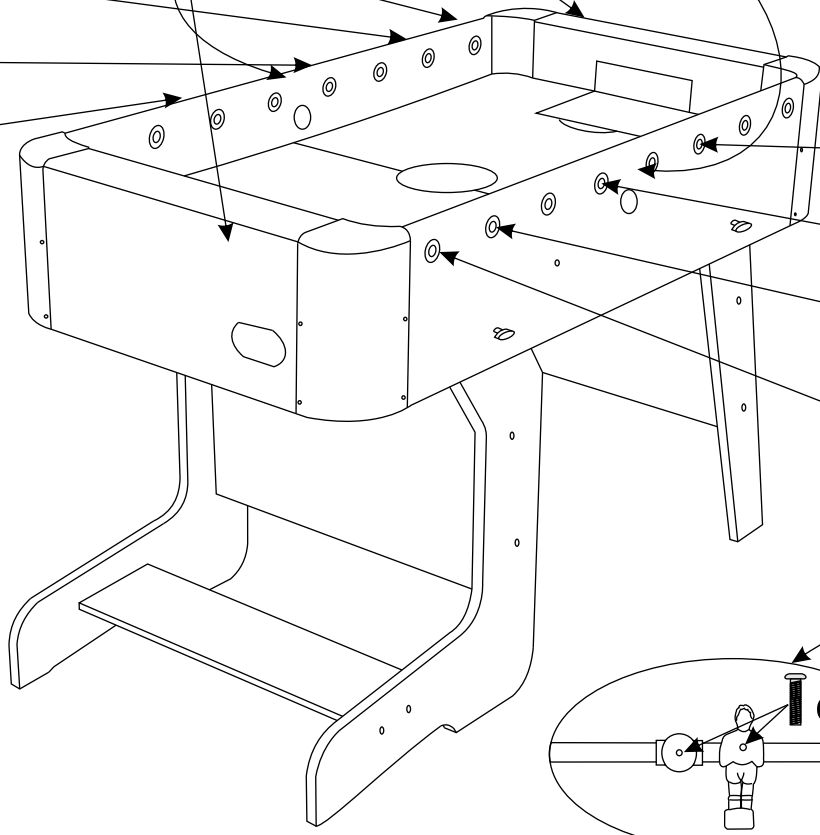
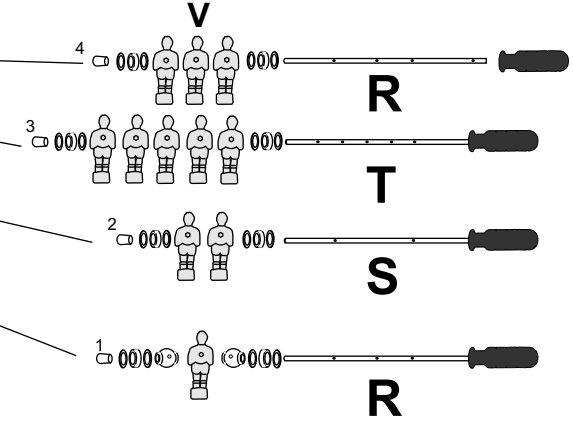
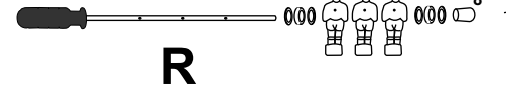
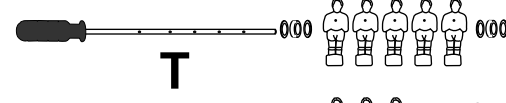
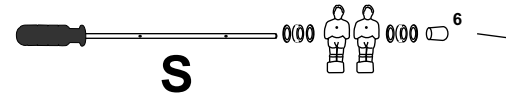
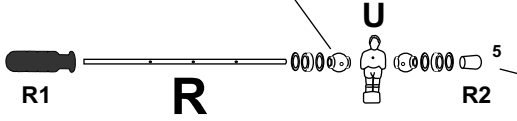
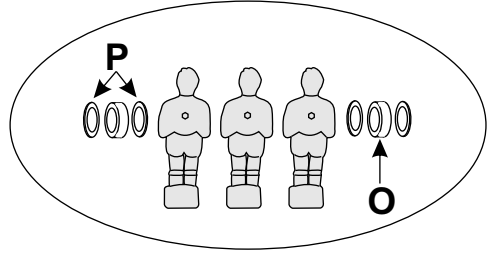
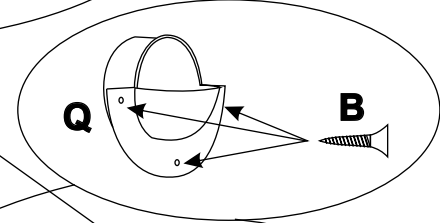
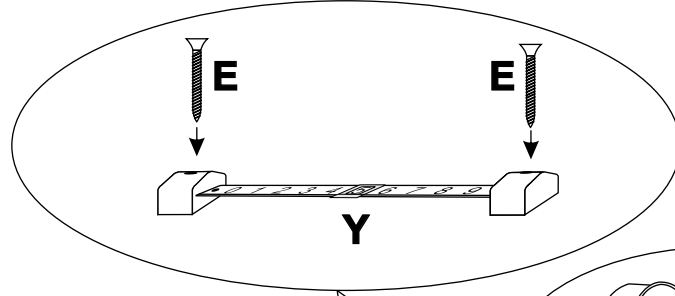
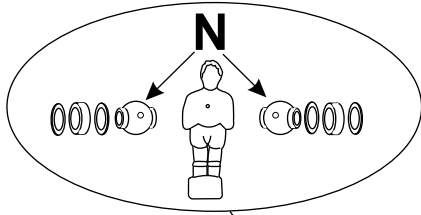

7