

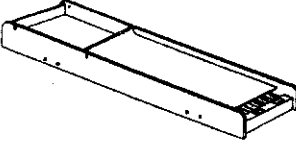

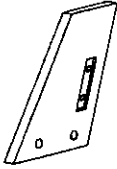

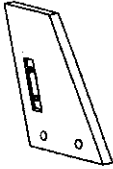

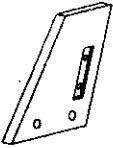

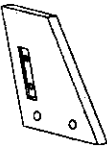
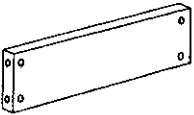
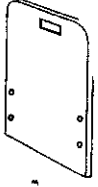
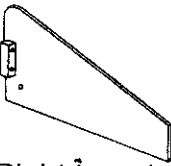
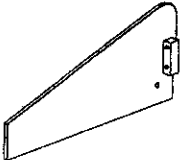
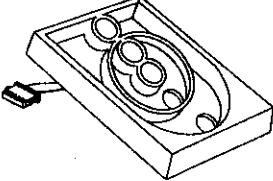
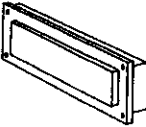

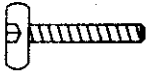

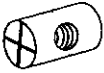
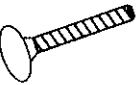

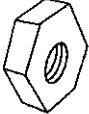

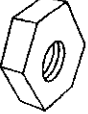

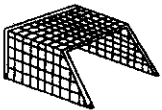
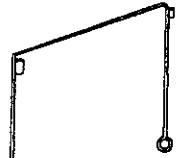
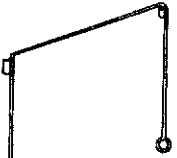
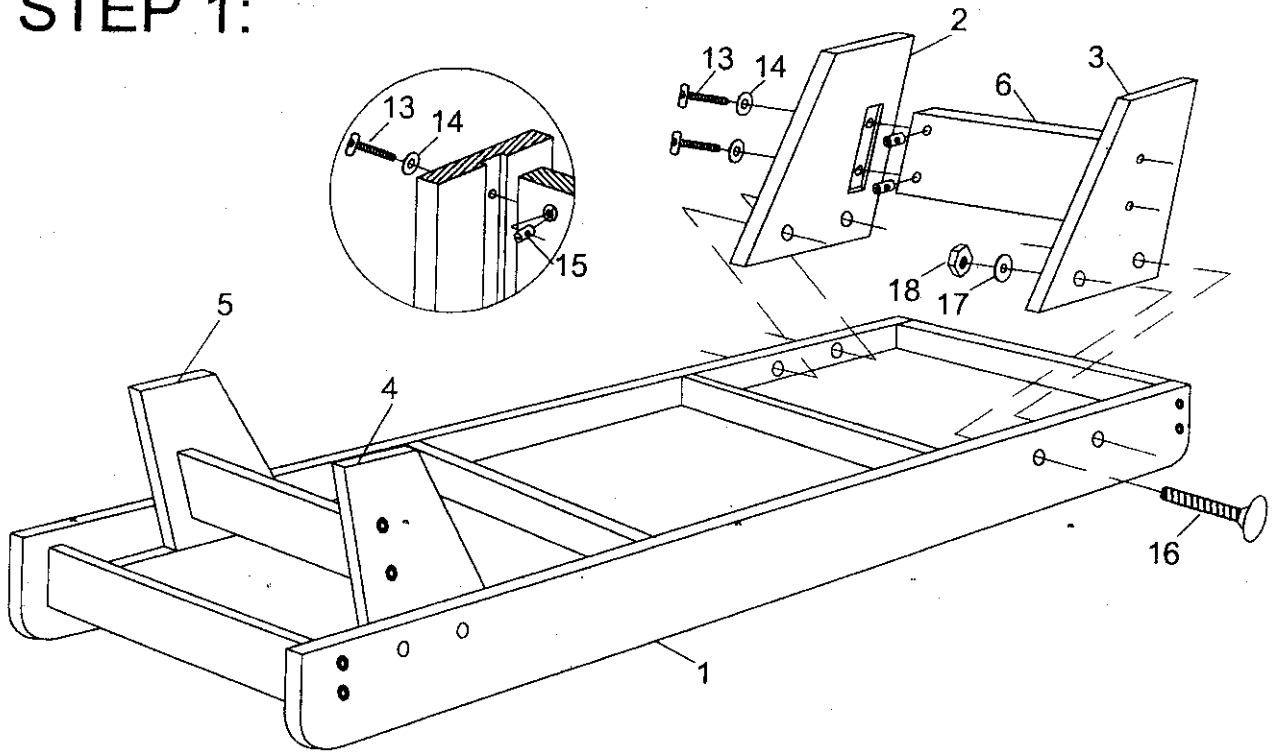
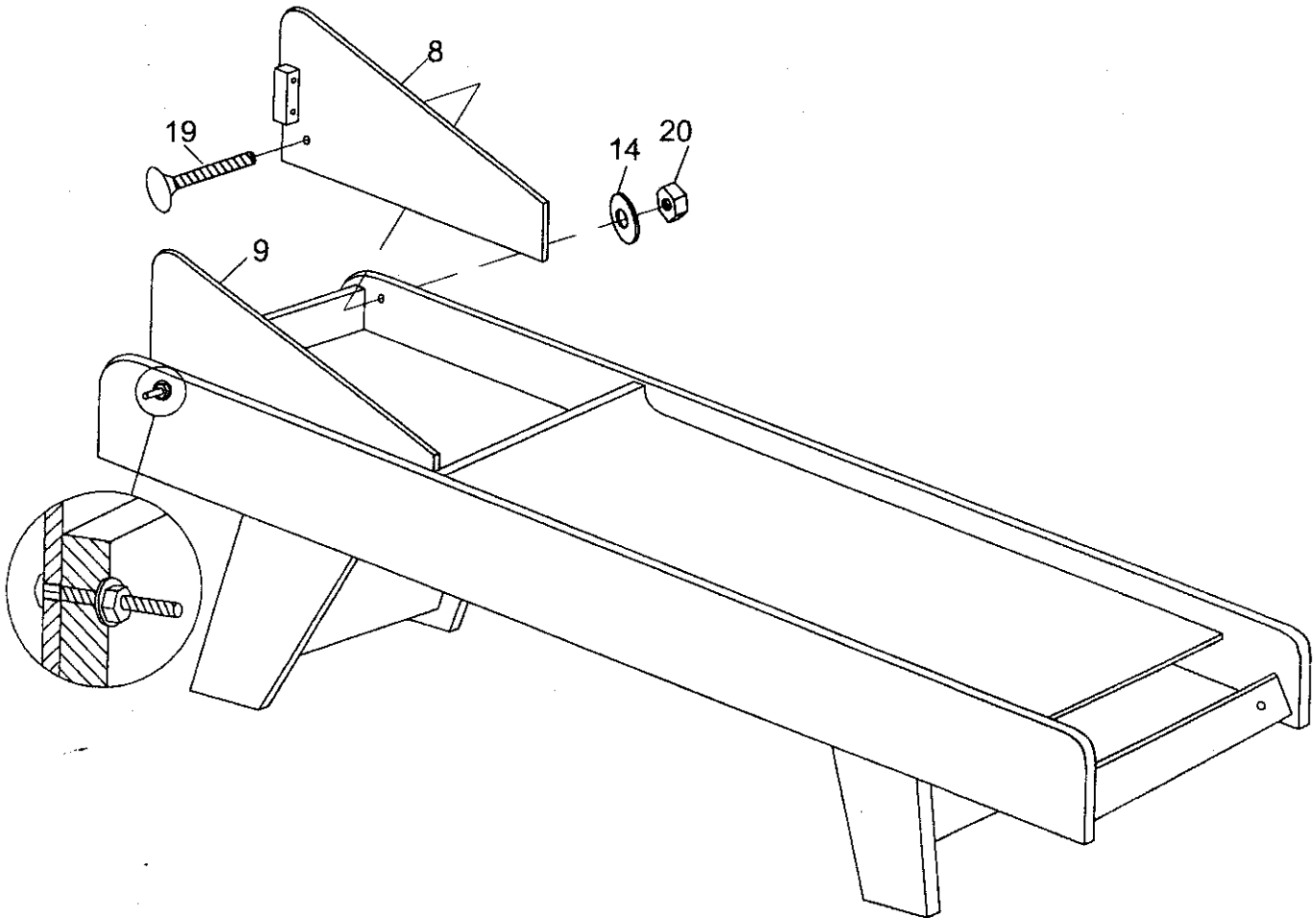
<p>#1</p>  <p>Main frame 1 piece</p>	<p>#2</p>  <p>Right back leg 1 piece</p>	<p>#3</p>  <p>Left back leg 1 piece</p>	<p>#4</p>  <p>Right front leg 1 piece</p>
<p>#5</p>  <p>Left front leg 1 piece</p>	<p>#6</p>  <p>Leg connection board 2 pieces</p>	<p>#7</p>  <p>Back board 1 piece</p>	<p>#8</p>  <p>Right target side panel 1 piece</p>
<p>#9</p>  <p>Right target side panel 1 piece</p>	<p>#10</p>  <p>Target board 1 piece</p>	<p>#11</p>  <p>Electronic Scorer 1 piece</p>	<p>#12</p>  <p>Ball 6 pieces</p>
<p>#13</p>  <p>Round socket head screw 1/4"X3" 8 pieces</p>	<p>#14</p>  <p>Steel washer 1/4" 18 pieces</p>	<p>#15</p>  <p>Barrel nut 1/4" 8 pieces</p>	<p>#16</p>  <p>Carriage bolt 5/16"X3" 8 pieces</p>
<p>#17</p>  <p>Steel washer 5/16" 8 pieces</p>	<p>#18</p>  <p>Hex nut 5/16" 8 pieces</p>	<p>#19</p>  <p>Carriage bolt 1/4"X2-1/4" 2 pieces</p>	<p>#20</p>  <p>Hex nut 1/4" 2 pieces</p>
<p>#21</p>  <p>Phillip head screw 1/2" 2 pieces</p>	<p>#22</p>  <p>Net 1 piece</p>	<p>#23</p>  <p>Net frame, back 1 piece</p>	<p>#24</p>  <p>Net frame, front 1 piece</p>

# STEP 1:

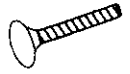

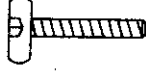
# STEP 2:

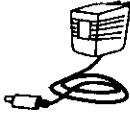

<p>#25</p>  <p>Steel bar 2 pieces</p>	<p>#26</p>  <p>Carriage bolt 1/4"x1-3/4" 2 pieces</p>	<p>#27</p>  <p>Acorn nut 1/4" 4 pieces</p>	<p>#28</p>  <p>Round socket head screw 1/4"x1-3/4" 4 pieces</p>
<p>#29</p>  <p>Hex wrench 1 piece</p>	<p>#30</p>  <p>Wrench 1 piece</p>	<p>#31</p>  <p>Adapter 1 piece</p>	<p>#32</p>  <p>T4X8MM Screw 4 piece</p>

### STEP 3:

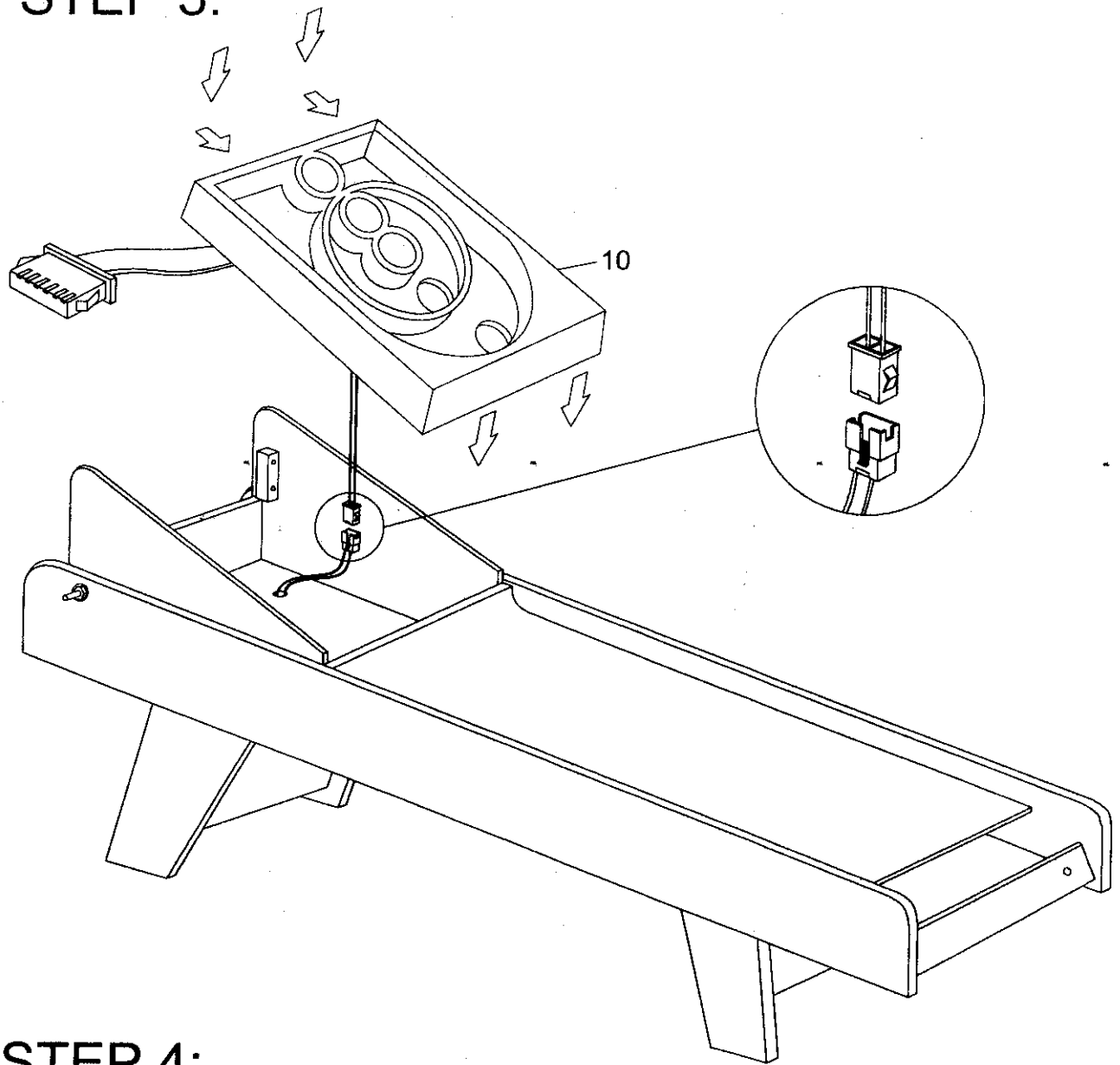

### STEP 4:

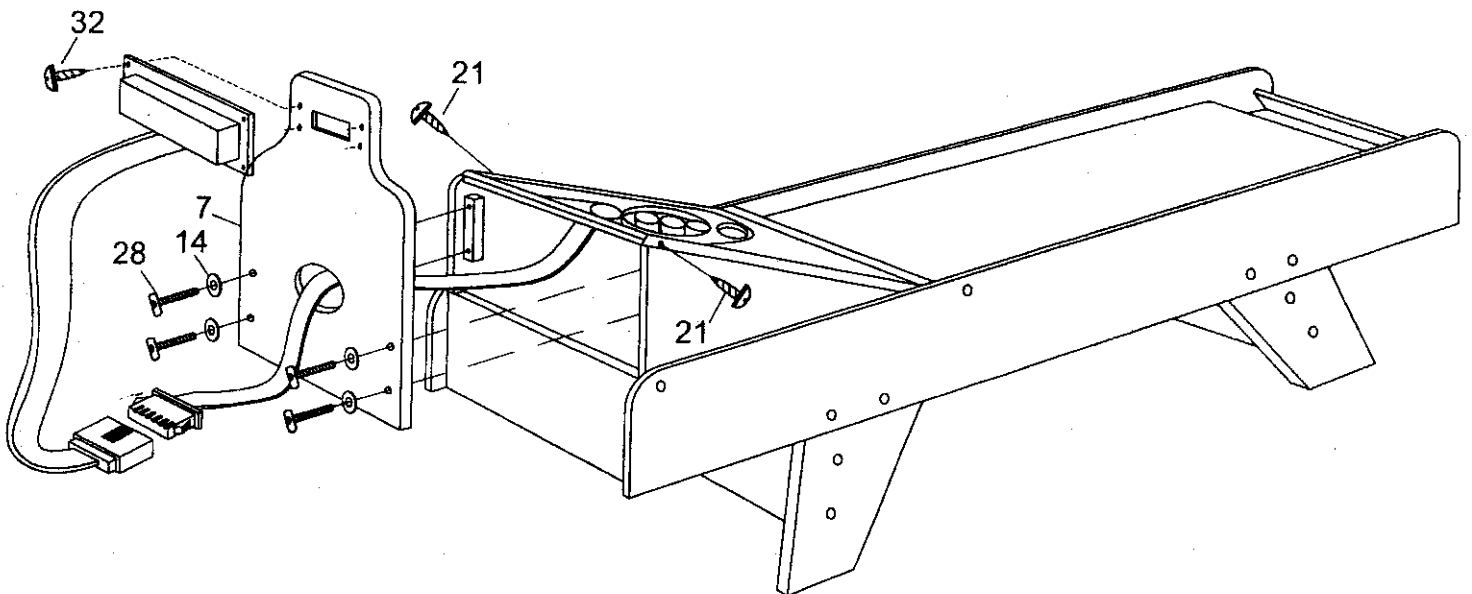

# STEP 5:

