

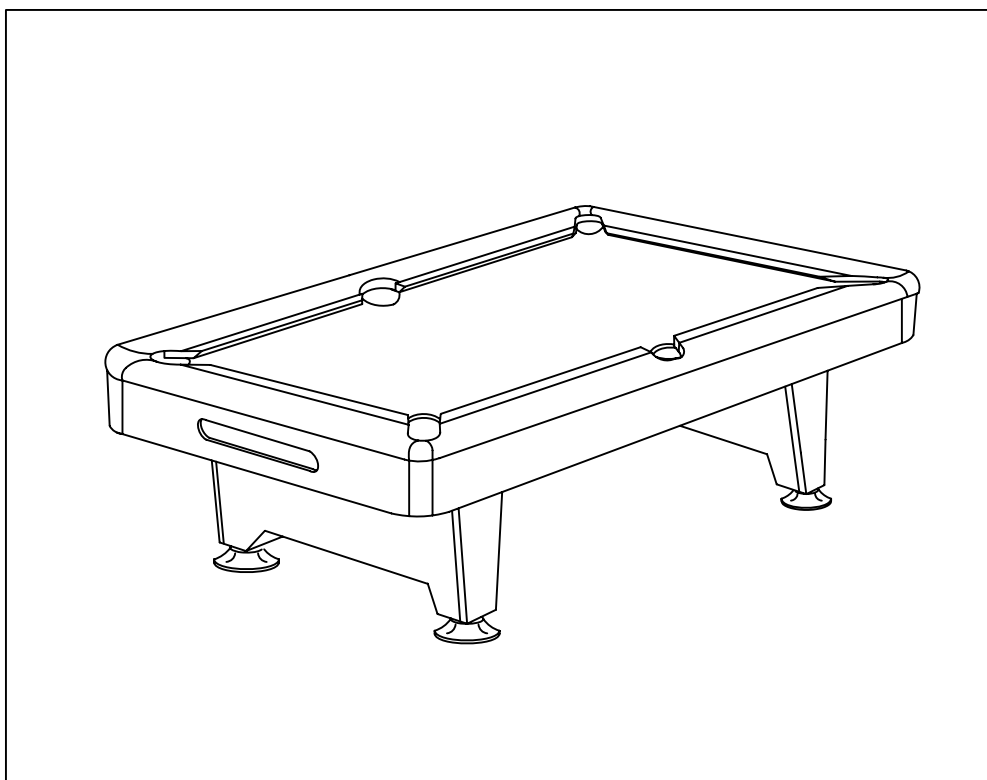

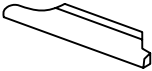

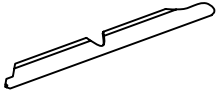

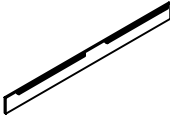



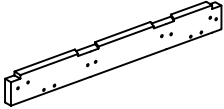
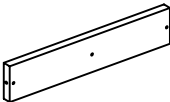

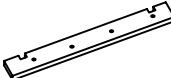
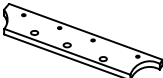

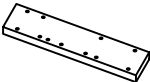
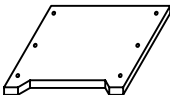
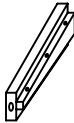

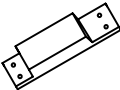
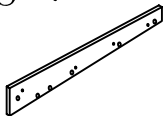

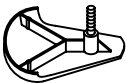

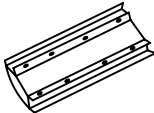

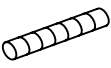





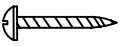
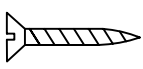



# BILLIARD TABLE

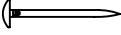
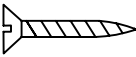
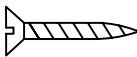

<p>#1</p>  <p>End rail 2 pieces</p>	<p>#2</p>  <p>Side rail 2 pieces</p>	<p>#3</p>  <p>Side apron 2 pieces</p>	<p>#4</p>  <p>End apron A 1 piece</p>
<p>#5</p>  <p>End apron B 1 piece</p>	<p>#6</p>  <p>Main beam 2 pieces</p>	<p>#7</p>  <p>Cross beam A 2 pieces</p>	<p>#8</p>  <p>Cross beam B 2 pieces</p>
<p>#9</p>  <p>Cross beam C 1 piece</p>	<p>#10</p>  <p>Cross beam D 2 pieces</p>	<p>#11</p>  <p>Cross beam E 2 pieces</p>	<p>#12</p>  <p>Leg Stretcher 1 piece</p>
<p>#13</p>  <p>Ball storage panel A 1 piece</p>	<p>#14</p>  <p>Leg panel 4 pieces</p>	<p>#15</p>  <p>Leg 4 pieces</p>	<p>#16</p>  <p>Leg join wood 4 pieces</p>
<p>#17</p>  <p>Leg panel join wood 2 pieces</p>	<p>#18 *</p>  <p>Ball return join wood 2 pieces</p>	<p>#19 *</p>  <p>Left&amp;Right Ball return 2 pieces</p>	<p>#20</p>  <p>Side rail 4 pieces</p>
<p>#21</p>  <p>leg leveler 4 pieces</p>	<p>#22</p>  <p>Apron corner 4 pieces</p>	<p>#23</p>  <p>Slate 1 set</p>	<p>#24 *</p>  <p>Basket 6 pieces</p>

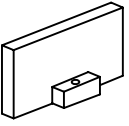
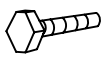
<p>#25</p>  <p>5/16"X2-1/2"Bolt 18 pieces</p>	<p>#26</p>  <p>5/16"X35mm Washer 18 pieces</p>	<p>#27</p>  <p>5/16"Nut 18 pieces</p>	<p>#28</p>  <p>1/4"X32mm Washer 4 pieces</p>
<p>#29</p>  <p>1/4"Nut 4 pieces</p>	<p>#30</p>  <p>Locker 4 pieces</p>	<p>#31</p>  <p>T4X1/2"Screw 40 pieces</p>	<p>#32</p>  <p>8#X1-1/2"Screw 32 pieces</p>
<p>#33</p>  <p>F4X1-1/4"Screw 38 pieces</p>	<p>#34</p>  <p>5/16"X1-1/2"Bolt 8 pieces</p>	<p>#35</p>  <p>5/16"*23mm Washer 8 pieces</p>	<p>#36</p>  <p>1/4"X2-1/2"Bolt 14 pieces</p>
<p>#37 *</p>  <p>1/4"X16mm Washer 14+2 pieces</p>	<p>#38</p>  <p>1/4"nut 4 pieces</p>	<p>#39</p>  <p>3/8"X2-1/4"Bolt 8 pieces</p>	<p>#40</p>  <p>3/8"Nut 8 pieces</p>
<p>#41</p>  <p>3/8"*25mm Washer 16 pieces</p>	<p>#42</p>  <p>Nail 40 pieces</p>	<p>#43 *</p>  <p>F4X1" Screw 11+28 pieces</p>	<p>#44</p>  <p>12#X1-1/2" Screw 12 pieces</p>
<p>#45</p>  <p>Wrench 1 piece</p>	<p>#46</p>  <p>Ball storage panel B 2 pieces</p>	<p>#47</p>  <p>1/4"*1-1/2"Bolt 2 pieces</p>	<p>#48</p>  <p>basket 6 pieces</p>

Step 1:

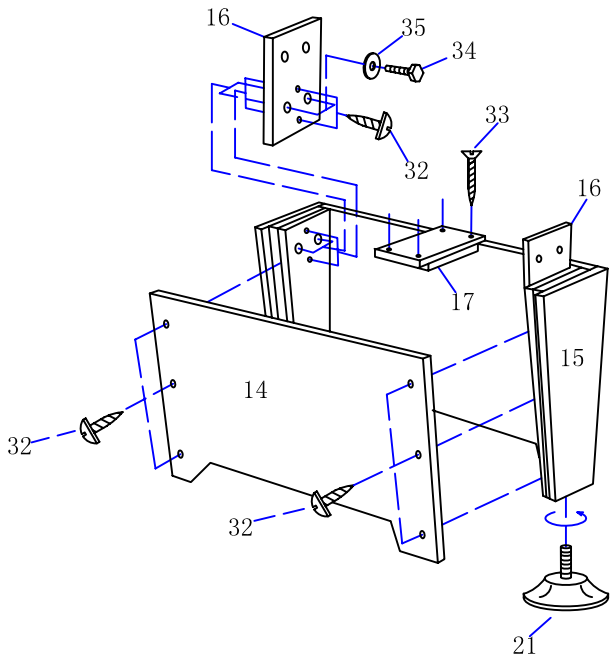

Step 2:

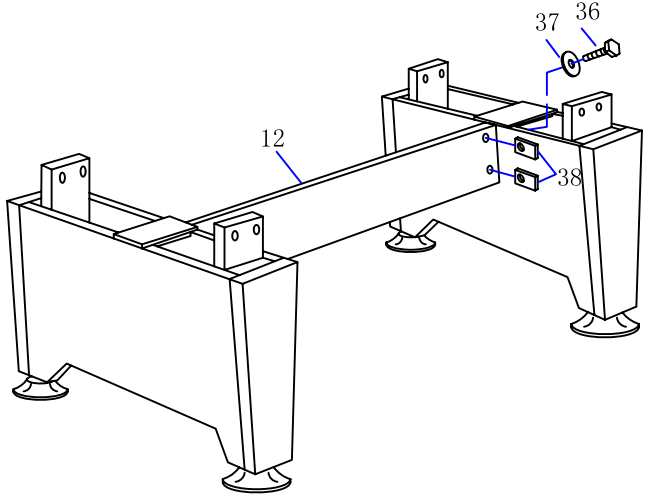

### Step 3:

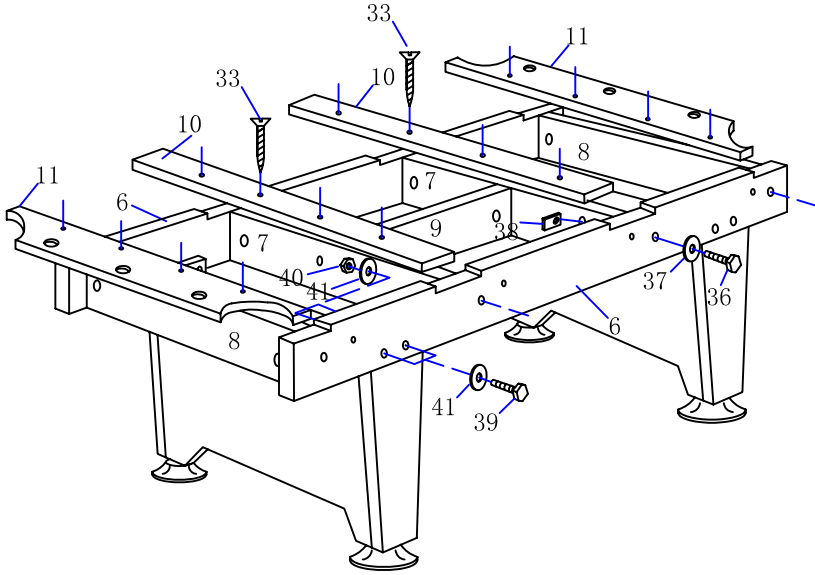

### Step 4:

Note: It doesn't have part#18 when it's with drop pocket, the assembly of part#18 is only available for the table with ball return system.

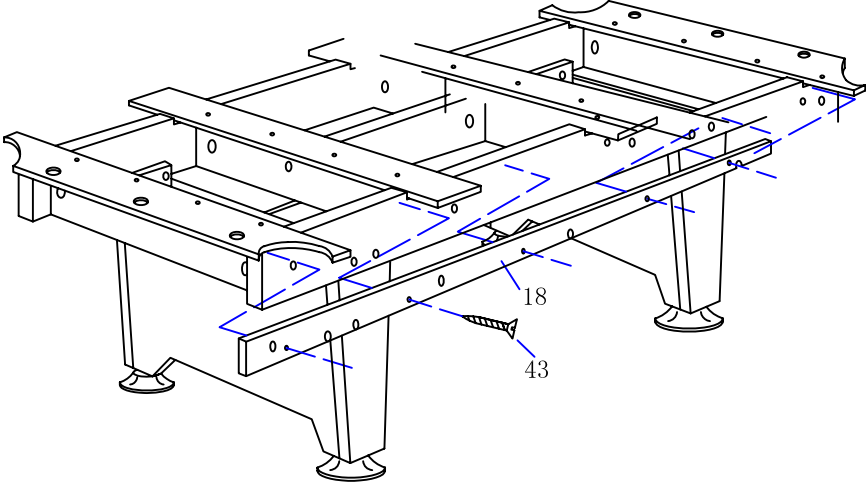

Step 5:

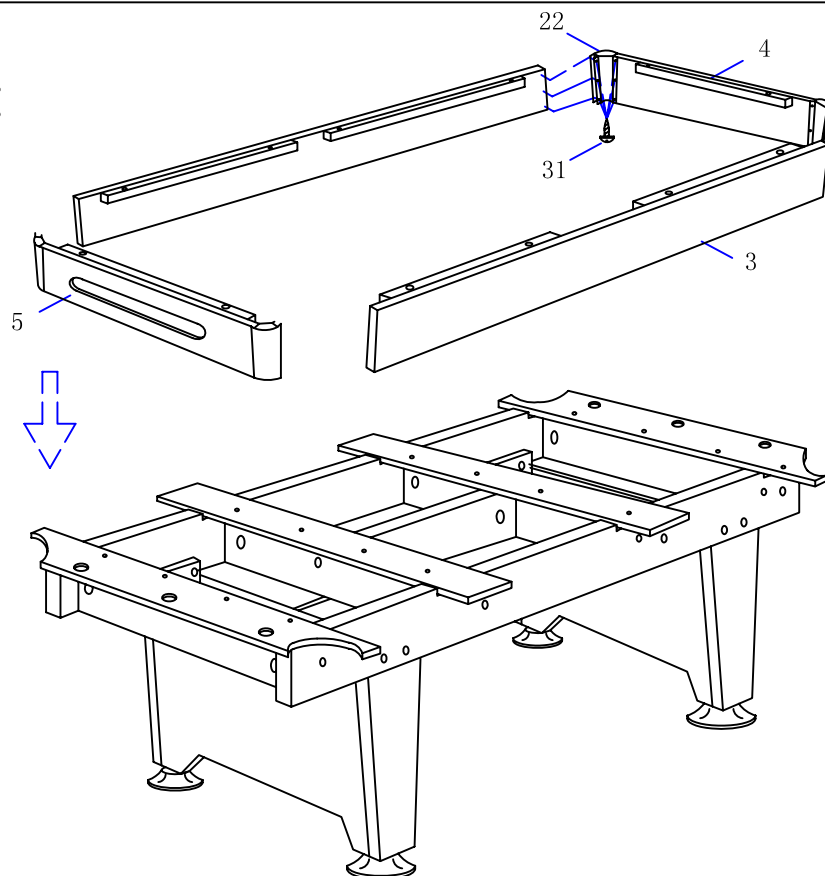

Step 6:

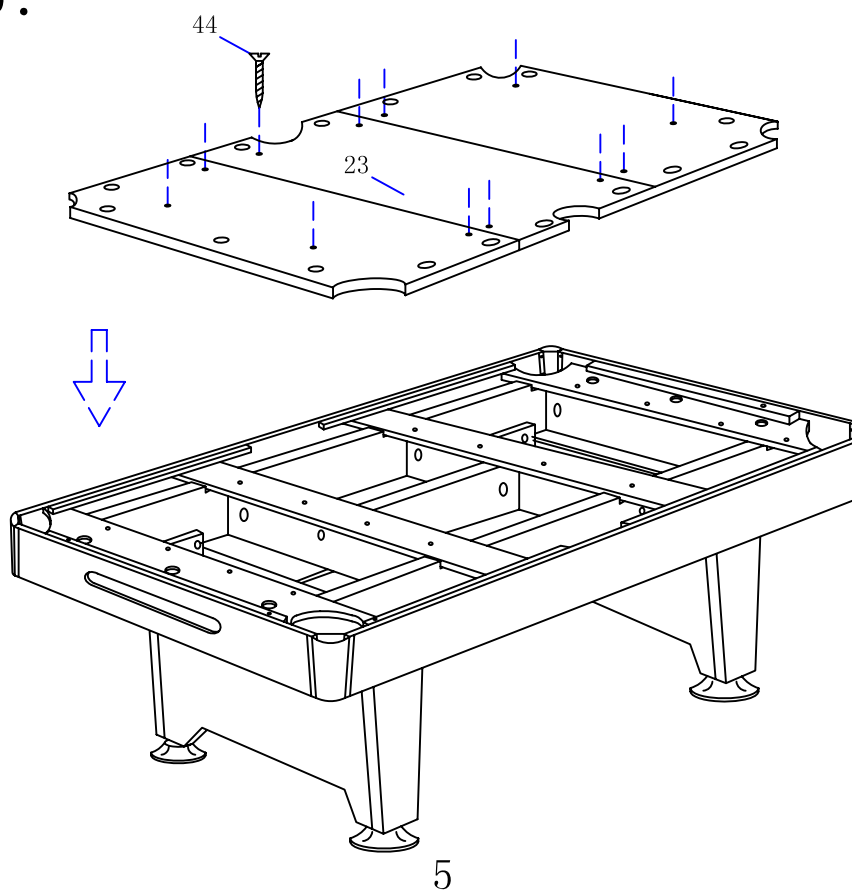

## Step 5:

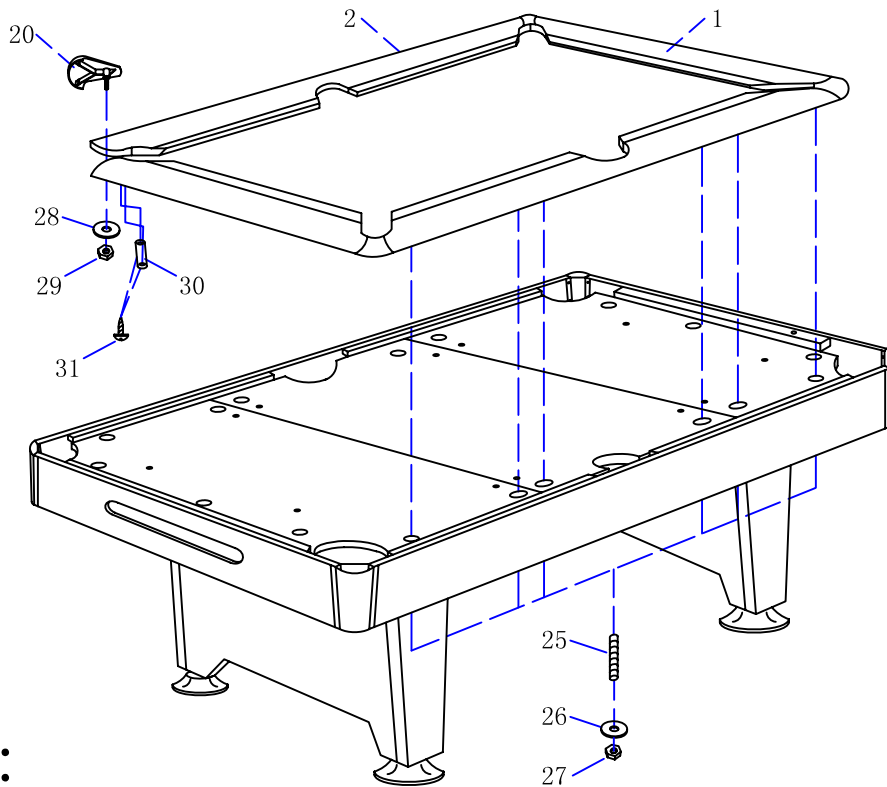

## Step 6:

Note: It doesn't have part#19 when it's with drop pockets, the assembly of part#19 is only available for the table with ball return system. Install part#19 and part#24 when it's with ball return system. But install part#48 instead of part#24 and install part#46 when it's with drop pockets.

